

**Grumman**

# **Grumman Body Parts Quick Reference Guide**

**Fleet Parts & Service, Inc.**  
590 Belleville Turnpike Building 22,  
Kearny, NJ 07032

Grumman

# Notes:

**ALUMINUM Z-POST 332-2D, E  
USED WITH FP4000R&L CORNER  
CAPS.**

**STEEL Z-POST 732-2D, E USED  
WITH FP4500R&L CORNER CAPS  
& FP4100R&L**

DISCLAIMER

*USE OF OEM OR MANUFACTURERS' NAME AND/OR PART NUMBERS IS FOR IDENTIFICATION PURPOSES AND SIMPLIFICATION ONLY AND IN NO WAY IS MEANT TO IMPLY THAT FLEET PARTS' ITEMS ARE AUTHORIZED OR IN ANY WAY AFFILIATED WITH THOSE MANUFACTURERS.*

# Grumman

## Part 01021- Grumman Vertical Connector

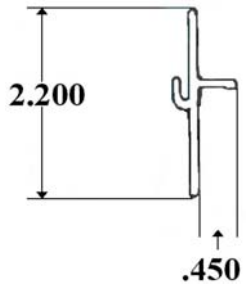

Used only with FP4100R & L  
Plastic Corner Caps

## Part 01026- Grumman Horizontal Connector

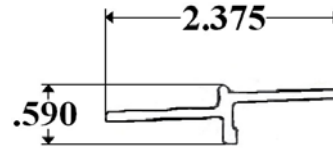

Used only with FP4100R & L  
Plastic Corner Caps

## Part 1014M- Corner Radius Grumman

M-Mill

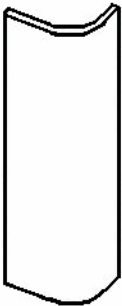

1014M 16.687 X 96"  
1014M/102 16.687 X 102"

Used only with FP4100R & L  
Plastic Corner Caps

## Part 332-2D (97"), 2E (108") & 2F (112")- Aluminum Z-Post Grumman

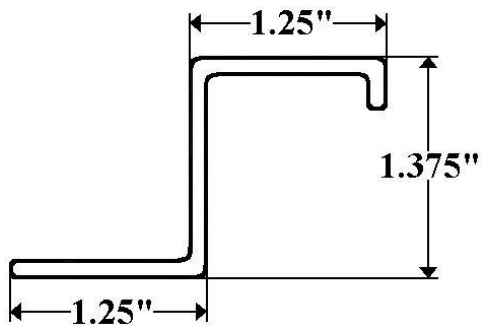

# Grumman

**Part 4002- Top Rail Grumman**

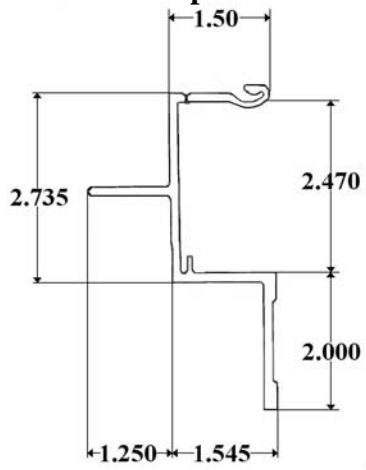

Use with Interlock

**Part 4003- Bottom Rail Grumman**

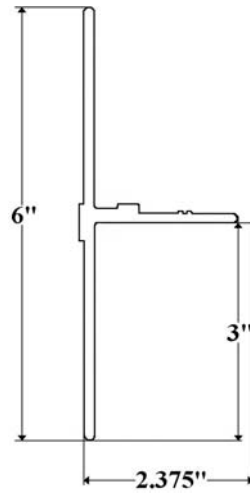

**Interlock for Grumman Top Rail**

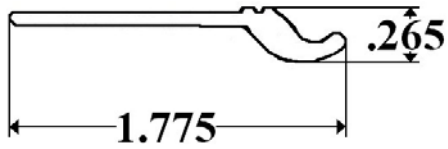

Use with 4002 Top Rail

# Grumman

**Part 4012/102- Grumman Roof Radius**

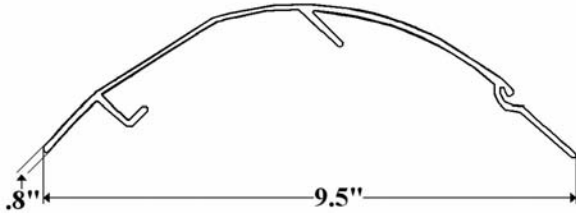

Used with FP4500R&L Corner Caps

**Part 4012L- Grumman Roof Radius  
Lower of 2 Pieces (Upper #4012U)**

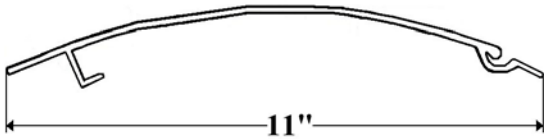

Used with FP4000R&L Corner Caps

**Part 4012M (Mill),  
4012PY (Penske Yellow)-  
Grumman Roof Radius**



Used with FP4100R&L Corner Caps

**Part 4012U- Grumman Roof Radius  
Upper of 2 Pieces (Lower #4012L)**

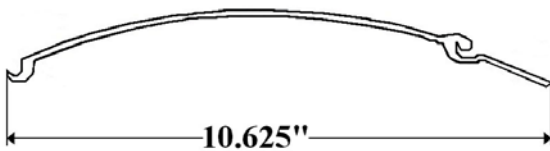

Used with FP4000R&L Corner Caps

# Grumman

**Part 419-1D (92.5) & 419-1E (98.5)-  
Roof Bow Grumman**

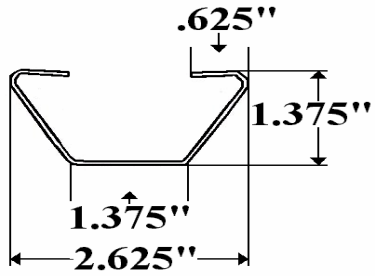

**Part 4030/103 (103.5")-  
Corner Post Grumman**

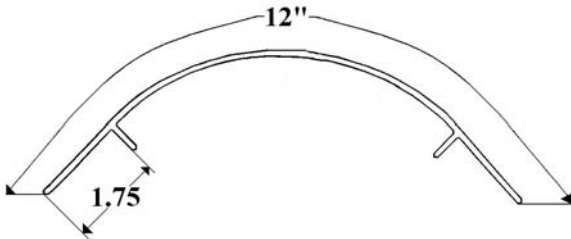

**Part 732-2D (96"), 2E (108") &  
732-NH (No Holes) for FRP Bodies-  
Grumman Steel Z-Post**

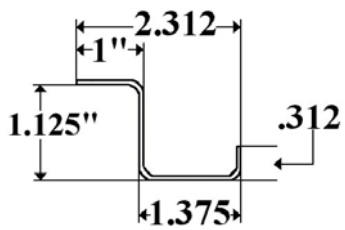

*Punched*

# Grumman

**Part FP4000AF- Grumman  
Rear Corner Cap**



**Part FP4000L- Grumman  
Left/Front Cap**

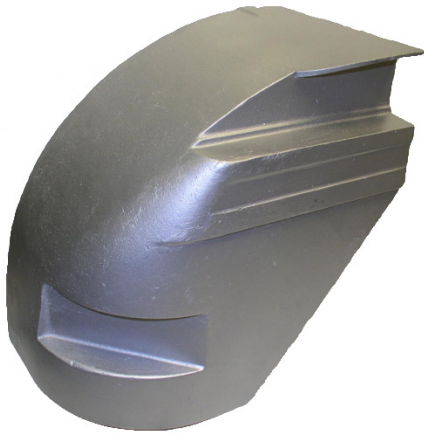

**Part FP4000R- Grumman  
Right/Front Cap**

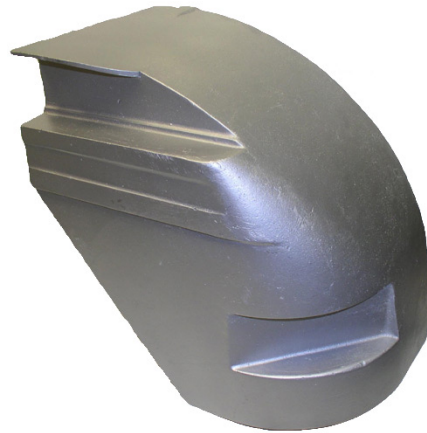

**Part FP4100L- Grumman Left/Front  
Plastic Cap**



**Part FP4100R- Grumman Right/Front  
Plastic Cap**



# Grumman

**Part FP4500L- Grumman  
Left/Front Cap**



**Part FP4500R- Grumman  
Right/Front Cap**



**Part FP4510L- Grumman  
Left/Front Cap**



**Grumman Family Van**

**Part FP4510R- Grumman  
Right/Front Cap**



**Grumman Family Van**



# Grumman

**Part GR1- Grumman Rear Header**

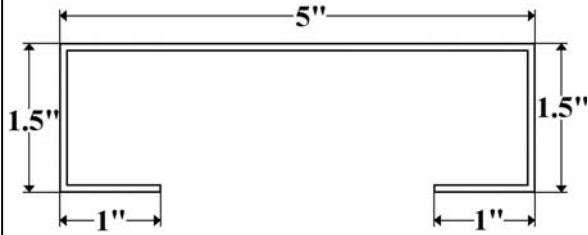

**Part GR2- New Grumman Rear Header**

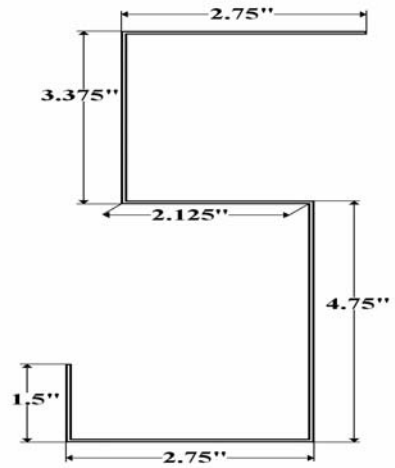

**Part GR3 (108'')- Grumman Rear Corner Post**

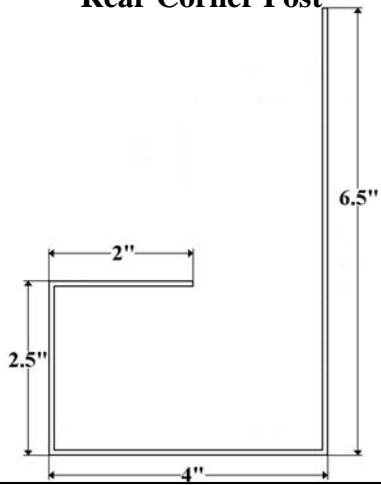

**Part GR3-1 (108'')- Grumman Rear Corner Post**

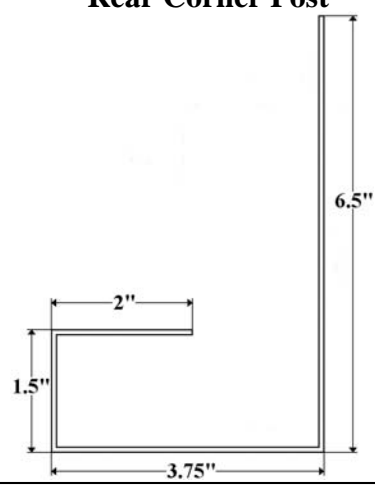

# Grumman

## Part S5022-Front Vertical Connector Grumman Aluminum Body

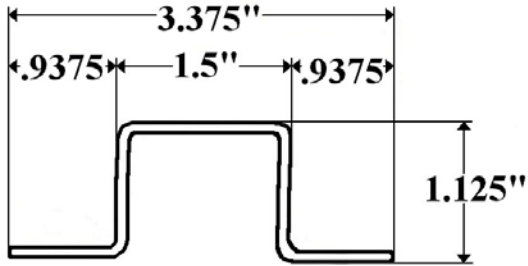

## T-Nut

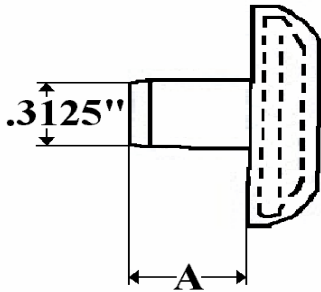

- 5/16-18 X 7/16" Grey
- 5/16-18 X 7/16" White
- 5/16-18 X 5/8" White

## T-Nut Bolt

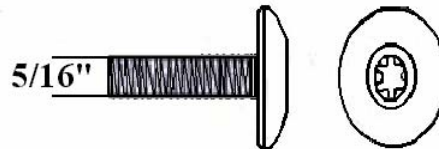

- 5/16-18 X 1/2" Torx HD
- 5/16-18 X 3/4" Torx HD
- 5/16-18 X 1" Torx HD

All with Patch  
Uses TX 40 Bit