

Utilimaster

# Utilimaster Body Parts Quick Reference Guide

**Fleet Parts & Service, Inc.**  
590 Belleville Turnpike Building 22,  
Kearny, NJ 07032

**Utilimaster**

# **Notes:**

DISCLAIMER

*USE OF OEM OR MANUFACTURERS' NAME AND/OR PART NUMBERS IS FOR IDENTIFICATION PURPOSES AND SIMPLIFICATION ONLY AND IN NO WAY IS MEANT TO IMPLY THAT FLEET PARTS' ITEMS ARE AUTHORIZED OR IN ANY WAY AFFILIATED WITH THOSE MANUFACTURERS.*

# Utilimaster

**Part 00010 (96") & 00010/108 (108")-  
Steel Slat Spacer FRP Body**

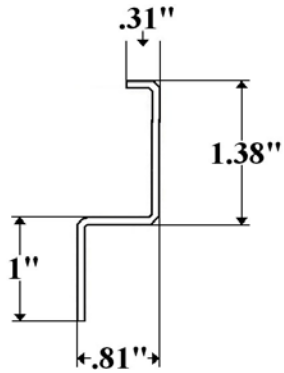

**Part 03020R&L-Utilimaster Vertical  
Connector Aluminum Body 108"**

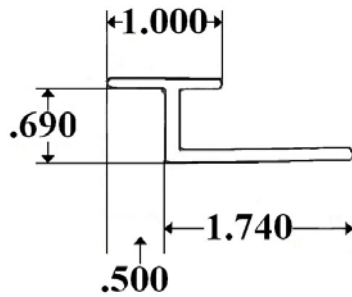

**Please Specify Right or Left  
03020L OEM # 06918985  
03020R OEM # 06918987**

**Part 3002- Utilimaster Top Rail**

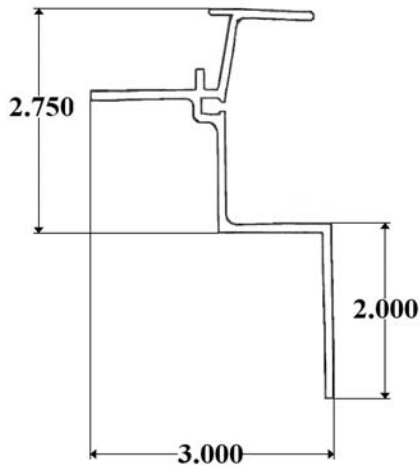

**Part 3003- Utilimaster Bottom Rail  
Thru 1/98**

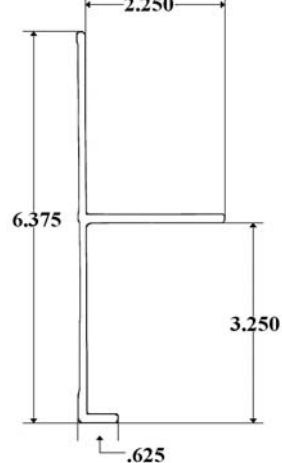

# Utilimaster

**Part 3004- Utilimaster Bottom Rail**  
*From 2/98*

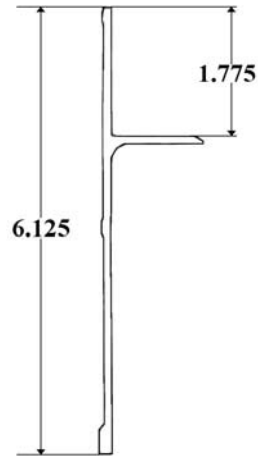

**Part 3005- Utilimaster Bottom Rail**  
*New Style*

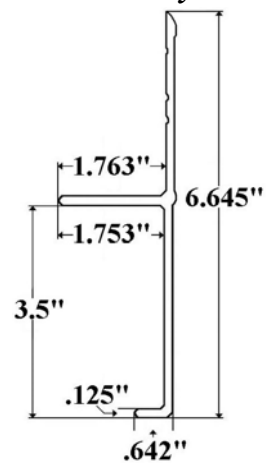

**Part 3007- Utilimaster Top Rail New Style**

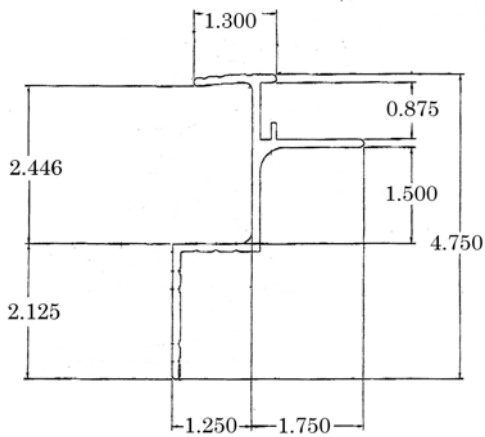

**Part 3009- Utilimaster Rear Top Rail**

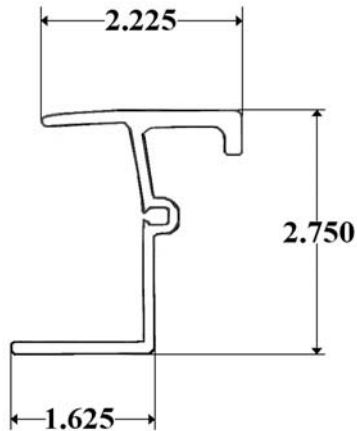

**Utilimaster Roof Radius *Mitred***

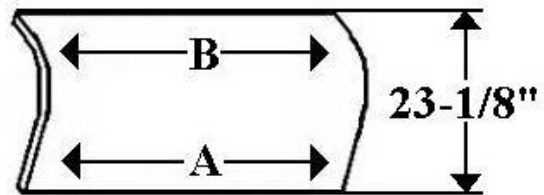

	A	B	
3012RY	80"	X 88-1/2	Ryder Yellow
3012M	84"	X 92-1/2	Mill
3012M2	90"	X 98-1/2	Mill

# Utilimaster

**Part 3050/92.5 (92.5'') & 98.5 (98.5'')-  
Starter Bow Utilimaster**

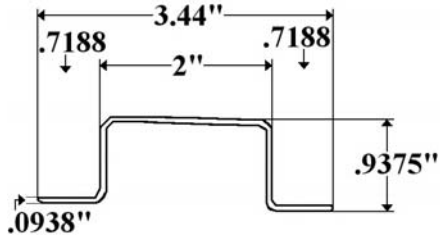

**Part 321-1C (88.5''), 1D (92.5'') &  
321-1E (98.5'')-  
Roof Bow Utilimaster**

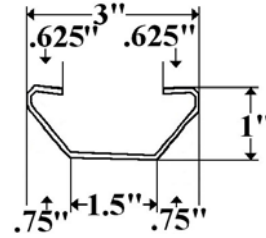

**Part 330-2D (96'')- Utilimaster  
Steel Z-Post Aluminum Body 1998**

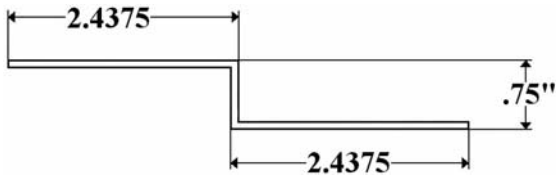

**Utilimaster Corner Radius**

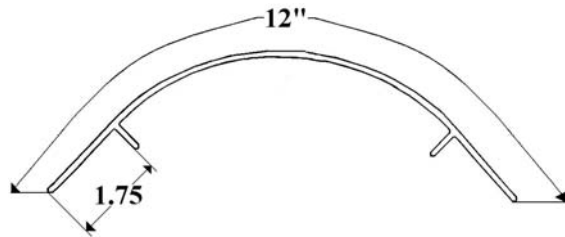

4030/103	12''	X	103.5''	Extruded
4030/112	12''	X	112''	Extruded

## SQUARE CORNER HINGE

### No. 4040

Square corner rear door hinge. All steel, this hinge allows door to swing 270° for full opening. Supplied with non-removable pin. (Removable pin also available). Universal for right or left hand doors. Available Flush to 1/2" Offset.

**Specifications:**

**Bracket:** 8 ga x 5" x 4-1/2" Wide

**Strap:** 8 ga x 1-3/4" x 12-1/8" Long

**Pin:** 1/2" Dia.

**Finish:** Zinc plated

**Weight:** 3-3/4 lbs.

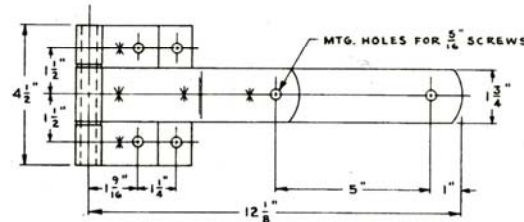
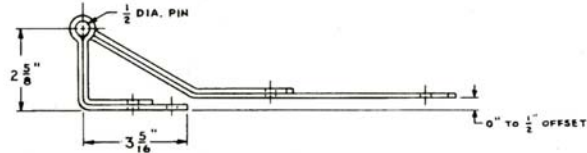
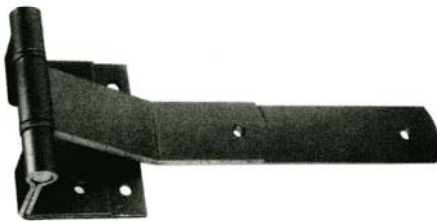

Part 732-2D (96") & 2E (108")-  
Utilimaster Steel Z-Post Aluminum Body

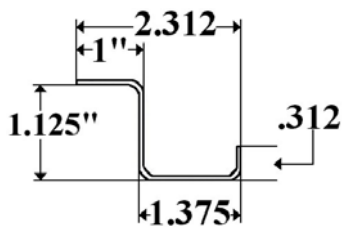

Part CGS- Utilimaster 1/4 H.D. Steel  
Corner Gusset

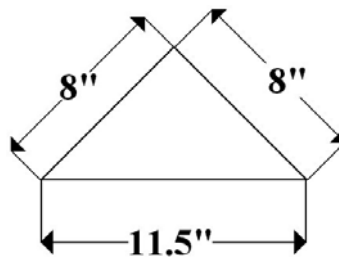

# Utilimaster

**Part FP3000AF– Utilimaster Rear Cap**



**Part FP3000L– Utilimaster  
Left/Front Cap**



**Part FP3000R– Utilimaster  
Right/Front Cap**



**Part FP3100L– Utilimaster  
Left/Front Corner Cap *New Style***



**Part FP3100R– Utilimaster  
Right/Front Corner Cap *New Style***



# Utilimaster

**Part FP3107L– Utilimaster Left Rear  
Corner Cap, New Style**



**Used with 3007 Top Rail**

**Part FP3107R– Utilimaster Right Rear  
Corner Cap, New Style**



**Used with 3007 Top Rail**



# Utilimaster

**Part GR2- New Utilimaster Rear Header**

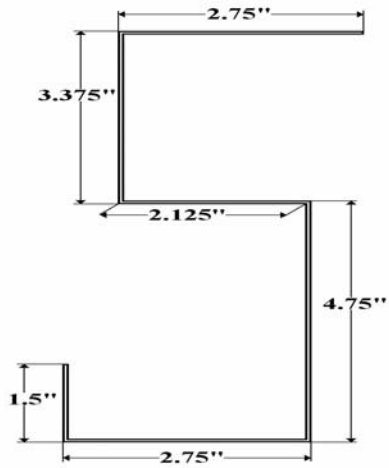

**Part UT1- Utilimaster Rear Header**

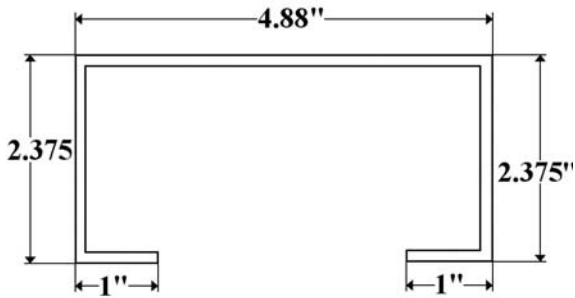

**Part UT3 (108")- Utilimaster Rear Corner Post**

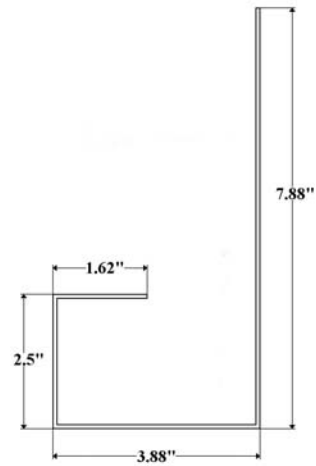

**FULL LINE OF:**

- **FASTENERS**
- **HARDWARE**
- **SEALANTS**
- **FRP**
- **ROOFING**
- **PANELS**
- **TOOLS**
- **DOORS & PARTS**

## Utilimaster

**Fiberglass Cap #1900937- Utilimaster 96" Wide Body  
Penske Yellow**



**Fiberglass Cap #20510266- Utilimaster 96" Wide Body  
Silver Ryder and Budget**



**Fiberglass Cap #20510915- Utilimaster 102" Wide Body  
Silver Ryder and Budget**

